

Official Copy



Nate Carr
Bronze Medal

SOUTH
CAROLINA
1989
AAAA
WRESTLING
TOURNAMENT

IRMO
HIGH SCHOOL

\$1.50



AAAA STATE WRESTLING SCHEDULE

FEBRUARY 18, 1989

ADMISSION: \$3.00

9:00 A.M.	Coaches Meeting
9:30	Round 1
11:00	Semi-Finals
12:15 P.M.	Break
12:45	Consolation Quarter Finals
1:30	Consolation Semi-Finals
2:30	Break
3:00	Consolation Finals
4:00	CLINIC -- NATE CARR, OLYMPIC BRONZE MEDALIST
6:00	Championship

Olympic Bronze Medalist

Nate Carr

- *Bronze Medalist in the 1988 Olympics
- *West Virginia Assist. Wrestling Coach
- *Three-Time NCAA Champion 1981, 82, 83
- *1984 USA Olympic Team Finalist
- *Two-Time Big 8 Champion
- *Collegiate record of 112-16-1
- *High School National Champion
- *High School record of 115-7



South Carolina is proud to have Nate Carr at the 1989 State AAAA Wrestling Tournament. Nate will arrive around noon, hold a clinic at 4:00 pm, sign posters, and present the awards at the Finals.

A number of local businesses and individuals have graciously sponsored Nate's trip. Sincere Thanks!

May excellence exist in all you do

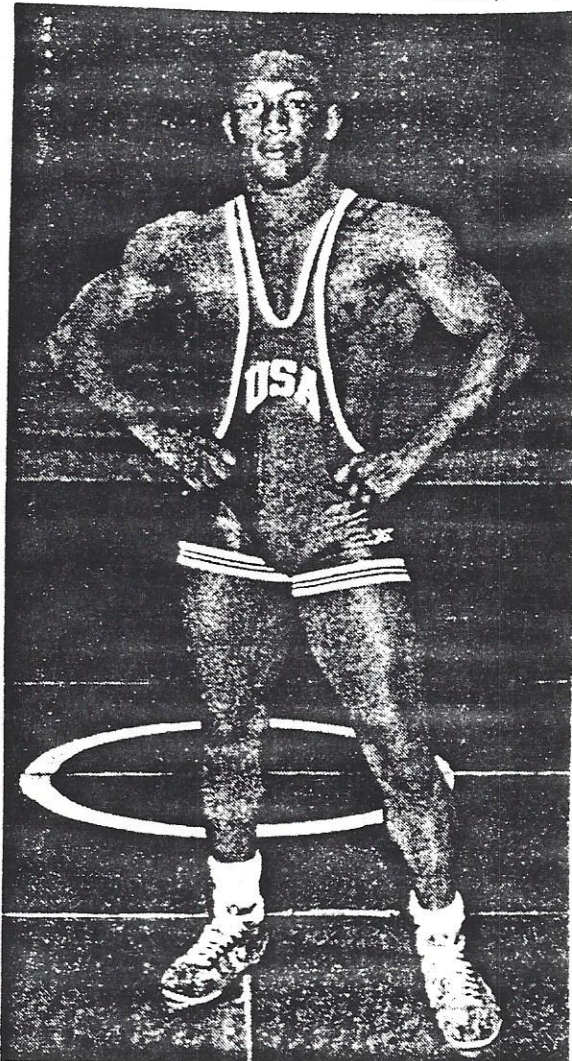

NATE CARR

149.5 POUNDS
NATE CARR, 28
Erie, PA
Morgantown, W.VA

One of the flashiest and most gifted wrestlers in America, Nate was a three-time NCAA champion at Iowa State University. He comes from a long line of wrestling brothers, as his older brother Jimmy made the 1972 Olympic team as a senior in high school, and brothers Fletcher, Joe and Michael were All-Americans in college.

He was the alternate to the 1984 Olympic team. Nate pulled off a major victory at the 1986 World Cup when he defeated world champion Raul Cascaret of Cuba. He won the National Open in 1988 after moving back to 149.5 pounds.

TEAM STATE TITLES

<u>YEAR</u>	<u>TEAM</u>	<u>COACH</u>
1972	Lower Richland	William Tourek
1973	Lower Richland	Rudolph Cooper
1974	Lower Richland	Rudolph Cooper
1975	Lower Richland	
1976	Airport	Jim Barnes
1977	Airport	Jim Barnes
1978	Airport	Jim Barnes
1979	Irmo	B. D. LaPrad
1980	Rock Hill	Tom Ellenburger
1981	Summerville	Steve LaPrad
1982	Rock Hill	Jim Barnes
1983	Rock Hill	Jim Barnes
1984	Rock Hill	Jim Barnes
1985	Rock Hill	Jim Barnes
1986	Rock Hill	Jim Barnes
1987	Summerville	Steve LaPrad
1988	Summerville	Steve LaPrad

SOUTH

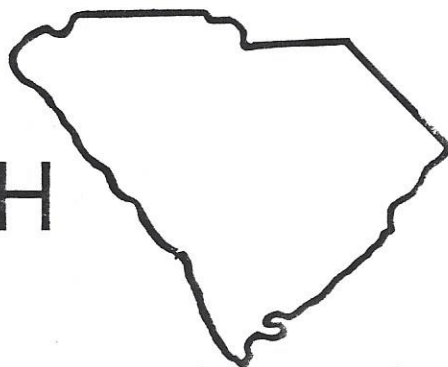

CAROLINA

RETURNING SC AAAA PLACERS

<u>NAME</u>	<u>SCHOOL</u>	<u>YEAR</u>	<u>WEIGHT</u>	<u>PLACE</u>
Alan Smith	Summerville	1987	101	2nd
		1988	115	1st
Chris Burns	Summerville	1986	101	2nd
		1987	108	1st
Brent Harper	Summerville	1988	122	4th
Jeff Cole	Summerville	1988	148	3rd
Marc Moore	Rock Hill	1987	141	4th
		1988	141	1st
James Jones	Rock Hill	1988	101	3rd
Jamie Gaffney	Rock Hill	1988	115	2nd
Lamar Thompson	Rock Hill	1988	122	3rd
Mike Johnson	Rock Hill	1988	178	2nd
Howard Jones	Spartanburg	1986	101	1st
		1987	108	2nd
James Boneparte	Orangeburg W.	1987	101	3rd
		1988	108	3rd
Troy Sheldon	Lexington	1988	108	4th
Jeff Fann	Irmo	1988	115	3rd
Mark Barnhill	Irmo	1987	101	4th
Mike Smith	Socastee	1988	115	4th
Domernic Caldwell	Northwestern	1988	170	2nd

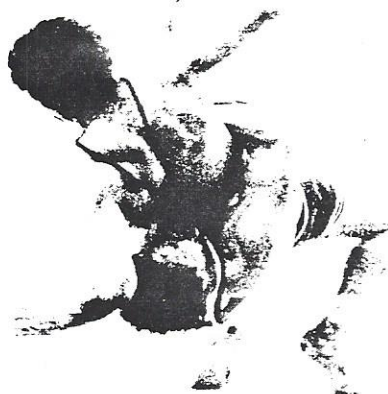

Scoring of Individual Match

TAKEDOWN	2 POINTS
ESCAPE	1 POINT
REVERSAL	2 POINTS
NEAR FALL	2 OR 3 POINTS
PENALTY	WARNING or 1 POINT TO OPPONENT

Team Scoring

Championship Bracket

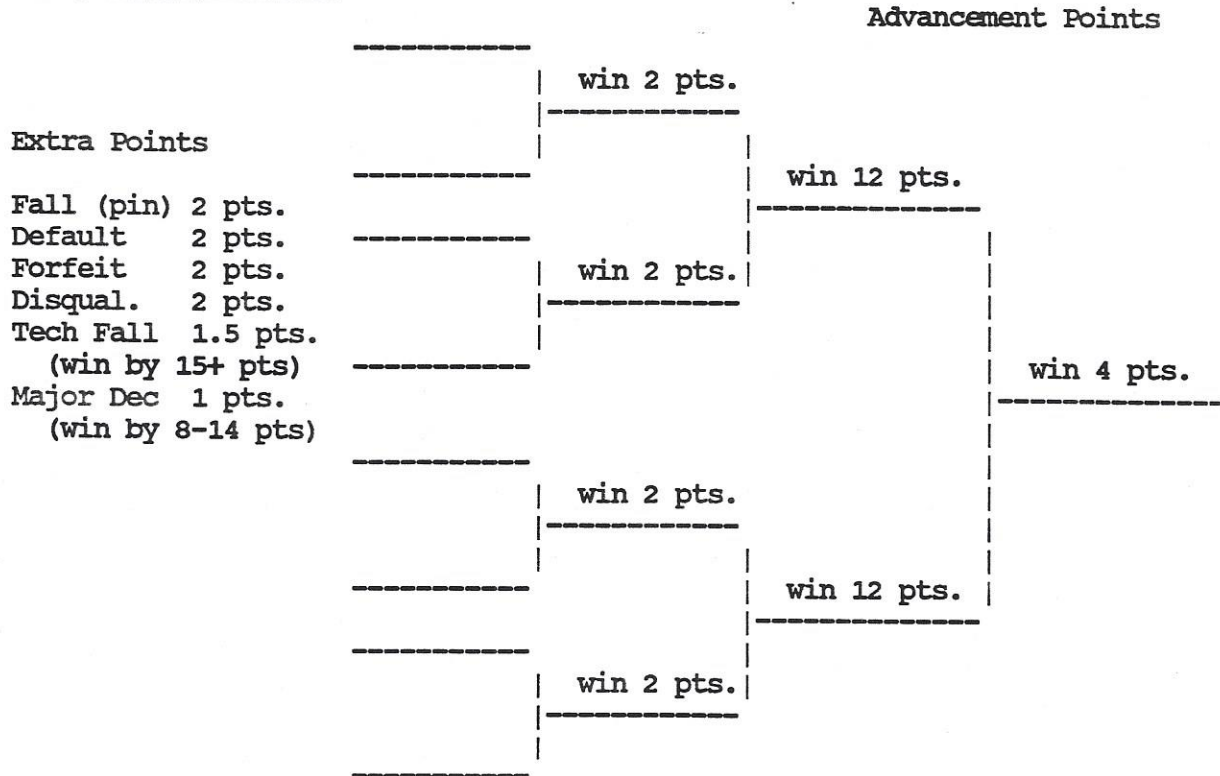

Consolation Bracket

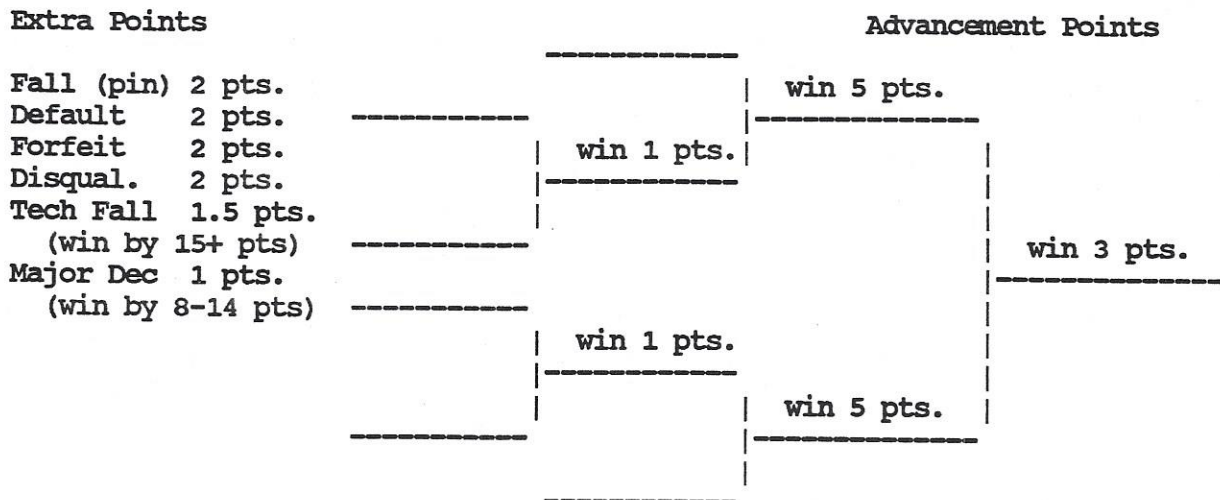

1989 STATE WRESTLING TOURNAMENT



Mister Donut:
6801 St. Andrews Rd.
Columbia, SC 29210

William B. Pierce
Owner

This sponsor has made it possible for Nate Carr to be at the SC Wrestling Tournament. Thanks!

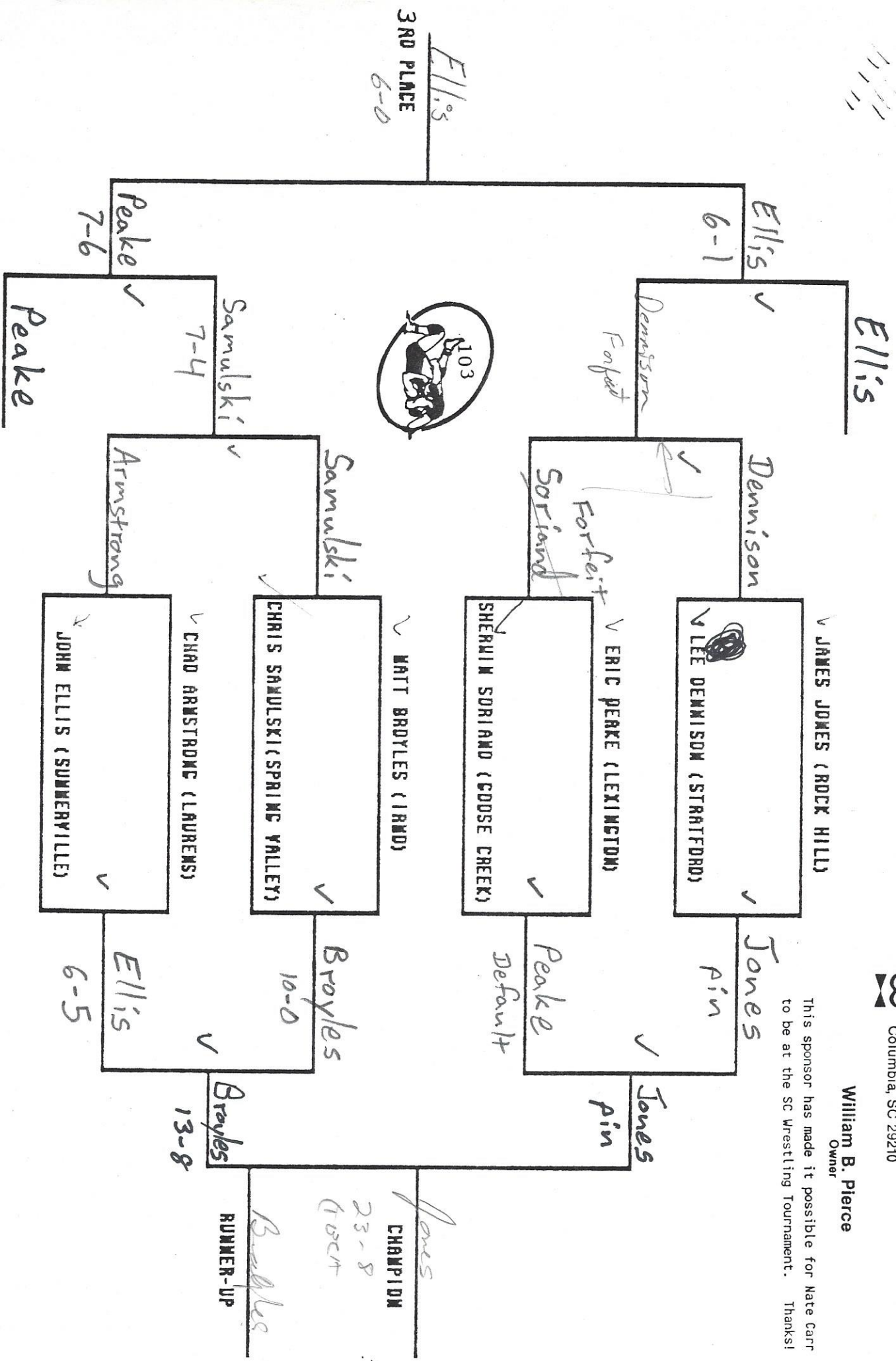

1989 STATE WRESTLING TOURNAMENT

Associates for
 Behavior and
 Child
 Development and
 Educational Resources

Barbara B. Savage, Ed. D.

By Appointment
 (803) 736-4545

9310 Two Not
 Columbia, SC

Savage
 3RD PLACE
 7-6

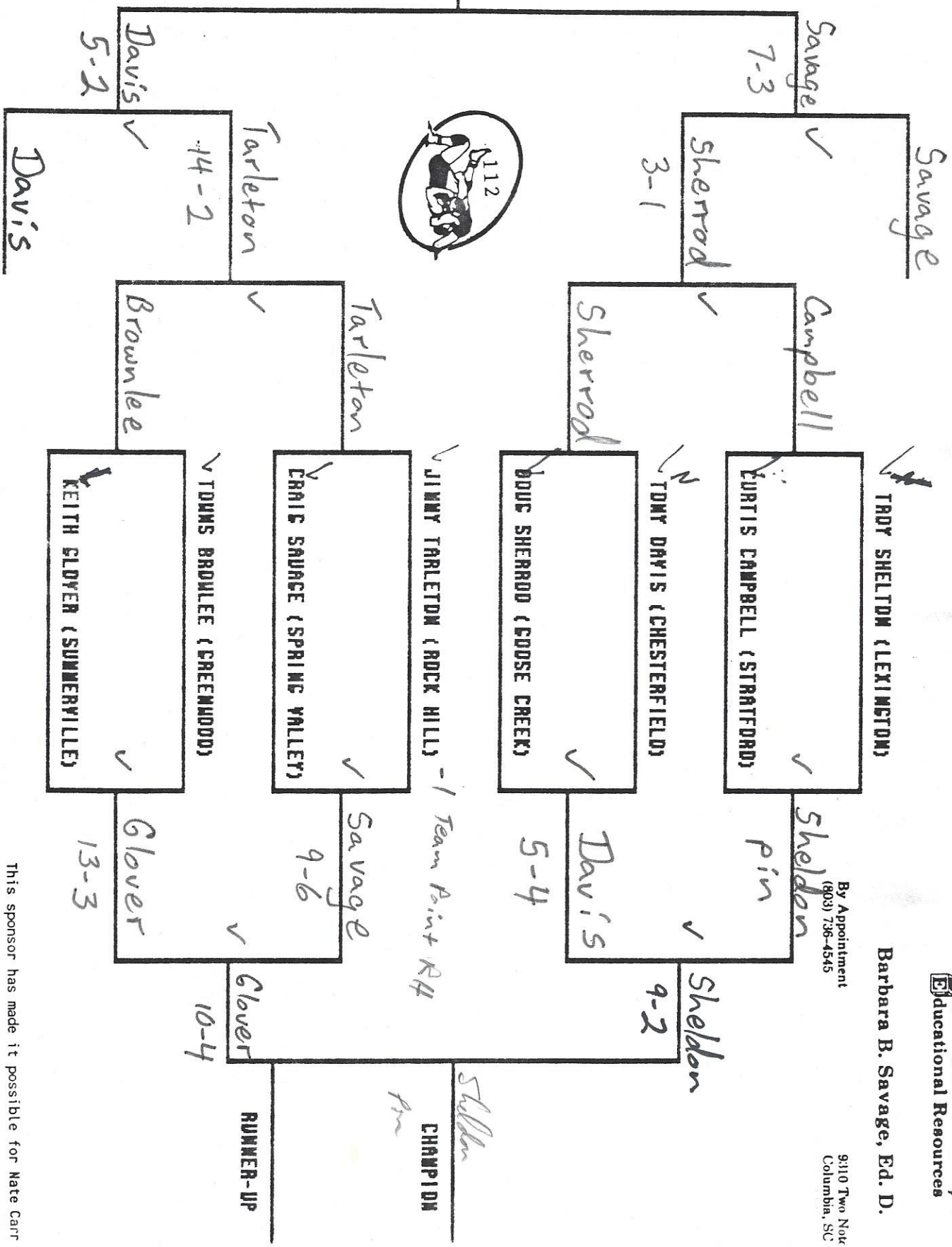

This sponsor has made it possible for Nate Carr
 to be at the SC Wrestling Tournament. Thanks!

1989 STATE WRESTLING TOURNAMENT

AMERICAN NATIONAL INSURANCE COMPANY

Depend on
AMERICAN
NATIONAL
For All Your
Insurance Needs.
LIFE, HEALTH, HOME



"FOR INFORMATION CALL"
GENERAL AGENT

Strickland Jimmy A & Associates
443 Meeting St W Columbia, SC 29203
791-8003

This sponsor has made it possible for Nate Carr to be at the SC Wrestling Tournament. Thanks!
Class 119 in memory of Brad Binkley

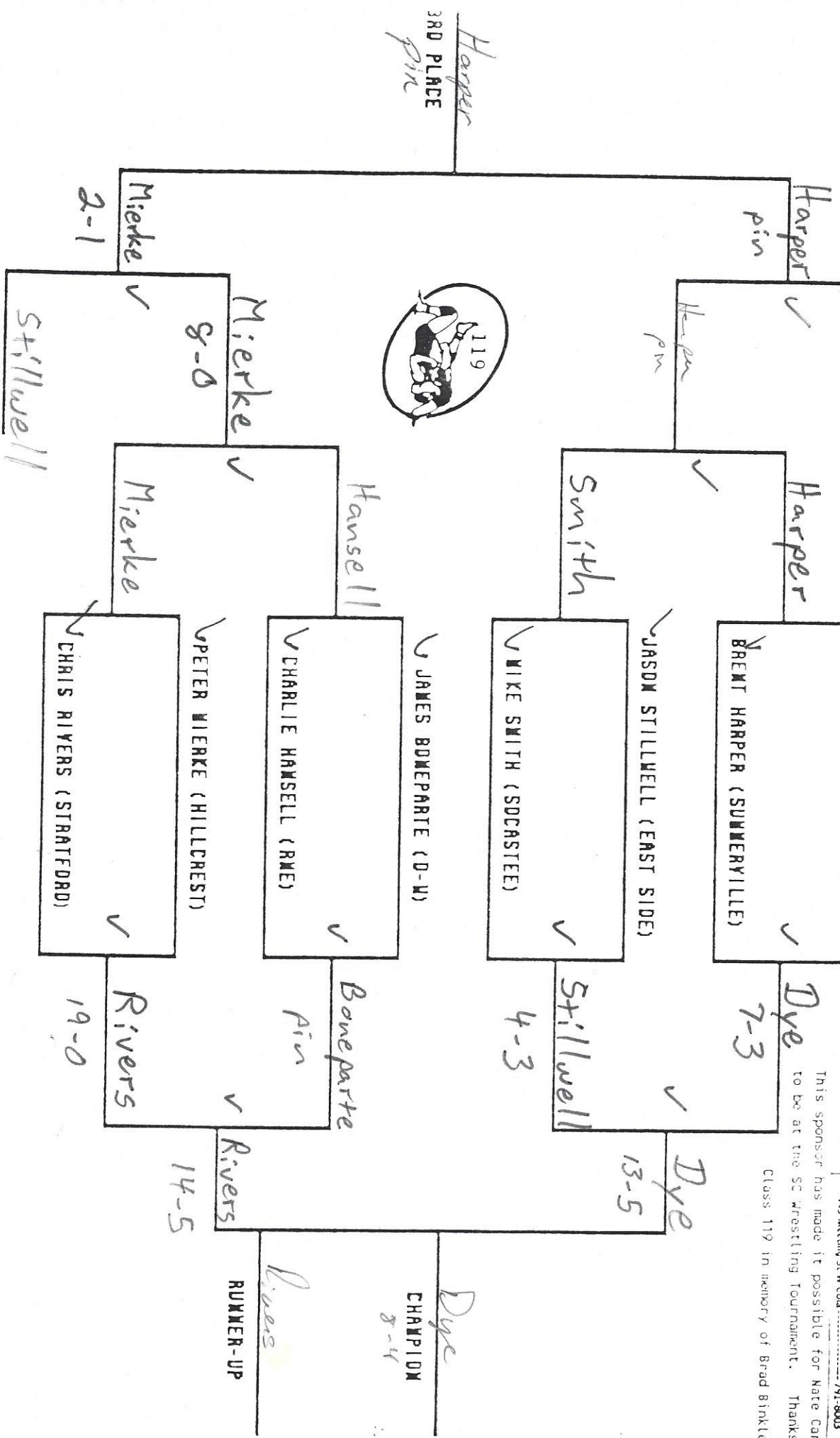

1989 STATE WRESTLING TOURNAMENT

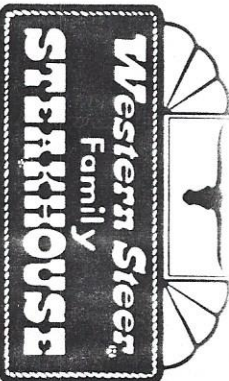

The place for Nate Carr after the Finals.

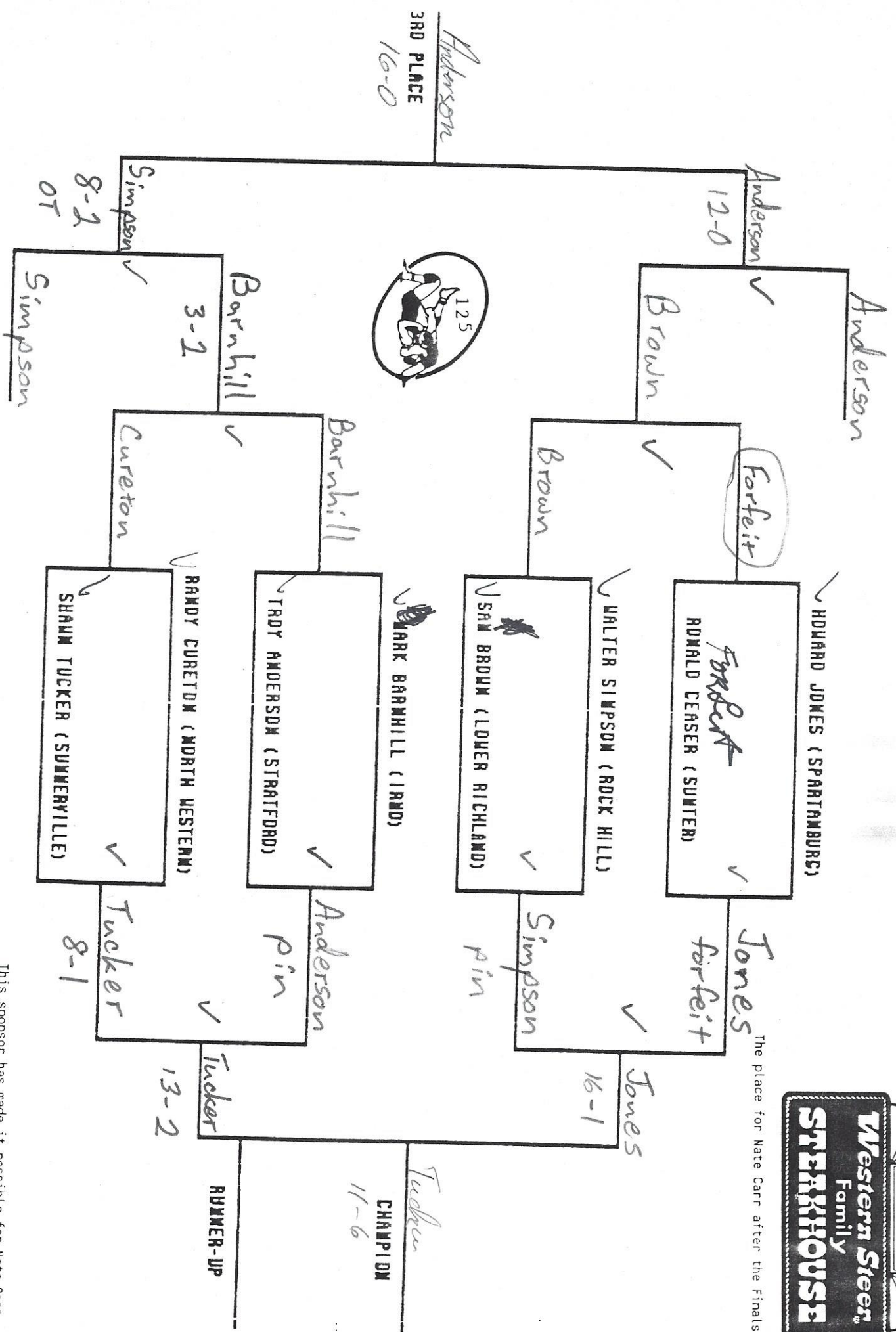

This sponsor has made it possible for Nate Carr to be at the SC Wrestling Tournament. Thanks!

1989 STATE WRESTLING TOURNAMENT

Econo Lodge
Spend a night, not a fortune.

292 Harbison Blvd. Columbia, SC 29212

ROOMS FROM \$26.95

This sponsor has made it possible for Nate Carr to be at the SC Wrestling Tournament. Thanks!

-1 Team Point RH

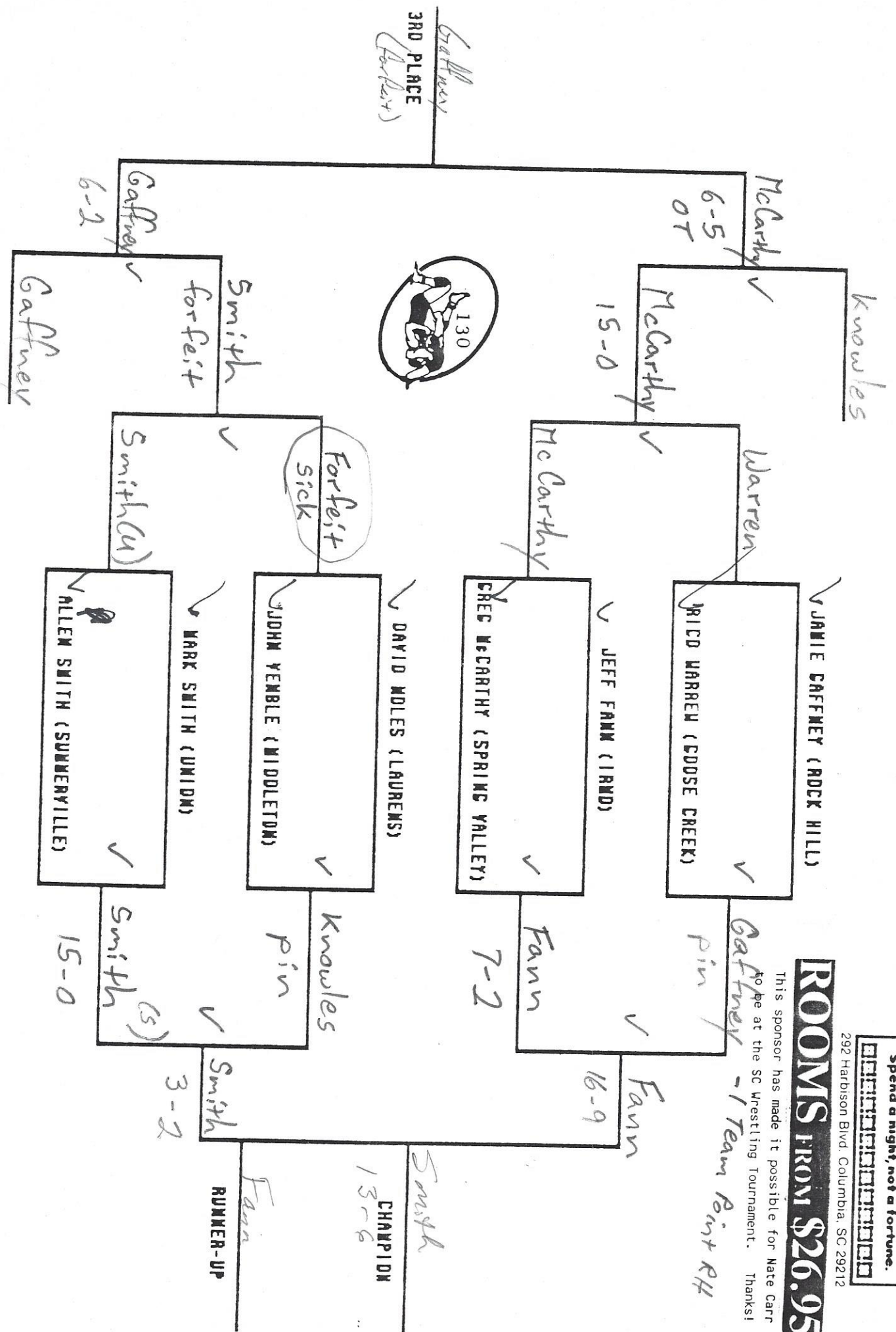

1985 STATE WRESTLING TOURNAMENT



This sponsor has made it possible for Nate Carr to be at the SC Wrestling Tournament. Thanks!

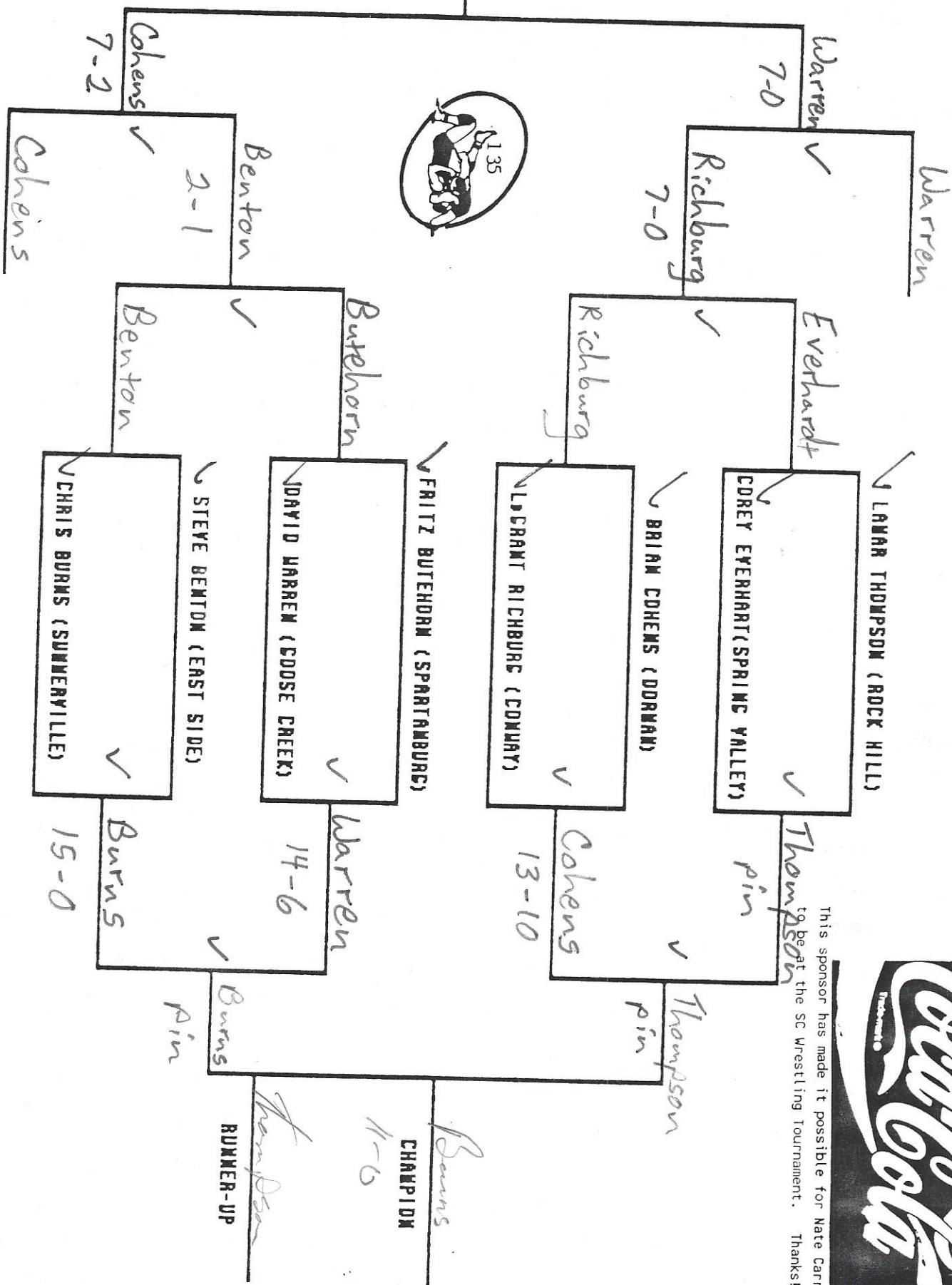

Warren
3RD PLACE
11-2

Burns
CHAMPION
11-6

Thompson
RUNNER-UP

1989 STATE WRESTLING TOURNAMENT

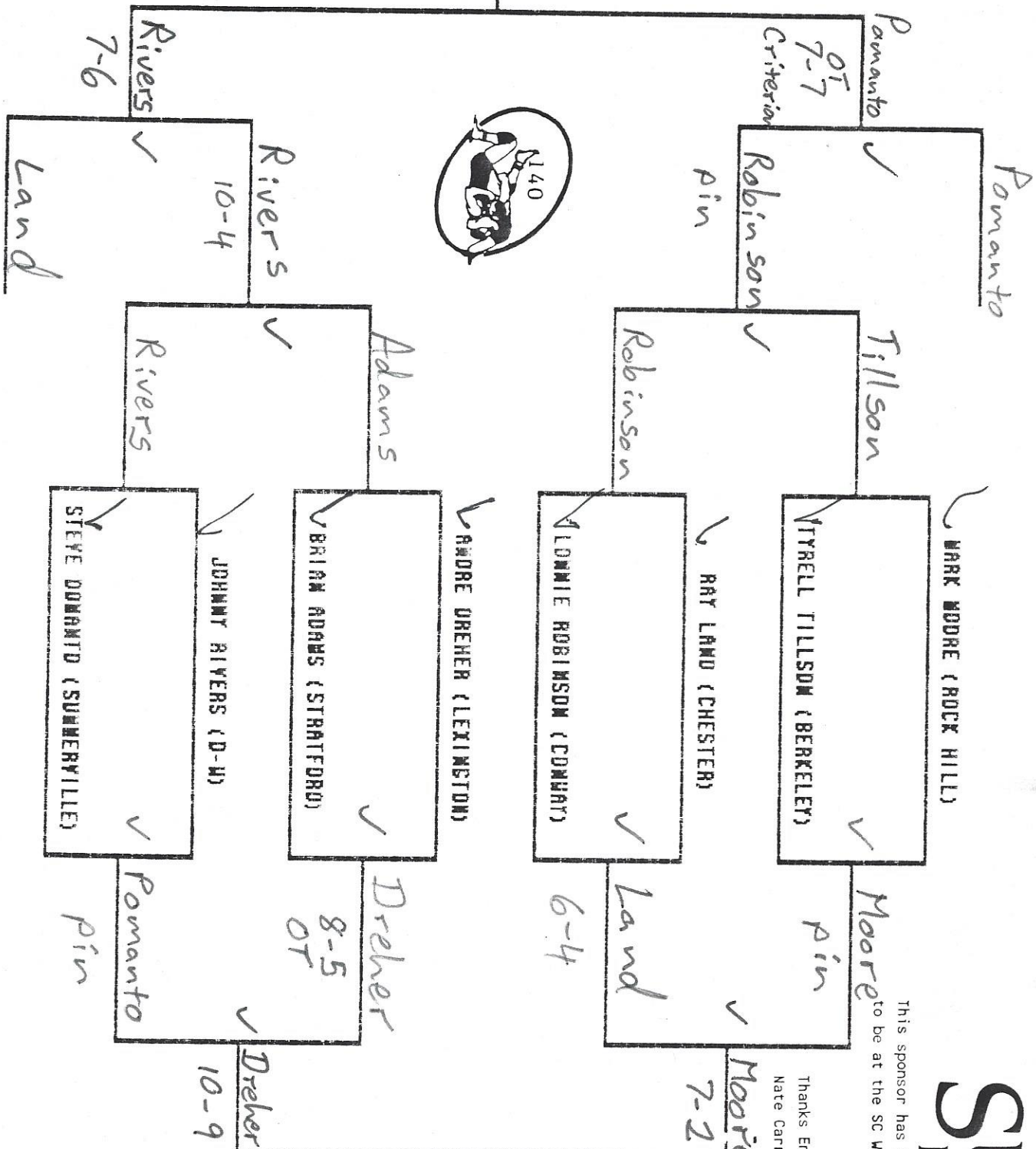

EMBASSY SUITES HOTELS

This sponsor has made it possible for Nate Carr to be at the SC Wrestling Tournament. Thanks!

Thanks Embassy Suites for providing Nate Carr with a room for Saturday.

Moore
 CHAMPION
 Dreher
 RUNNER-UP

1989 STATE WRESTLING TOURNAMENT

NOEXTER JOHNSON (NORTH WESTERN)

DOUG GEIGER (SPRING VALLEY)

NATE SMITH (DORRAN)

DOUG ALCORN (HARTSVILLE)

BERNARD DURHAM (ROCK HILL)

BERNARD PARKER (SUMMERYILLE)

P.K. ATWELL (WADE HAMPTON)

Johnson 9-1

Alcorn 16-5

Durham 2-1

Parker 9-3

Johnson

Pin

Durham

Pin

DATA SYSTEMS TECHNOLOGY, INC.

ONE HARRISON WAY SUITE 102
COLUMBIA, SC 29212
(803) 781-3035

This sponsor has made it possible for Nate Carr to be at the SC Wrestling Tournament. Thanks!

CHAMPION

RUNNER-UP

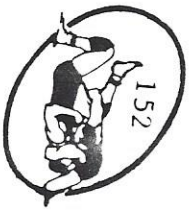

3RD PLACE

8-7

Parker

Parker ✓

Pin

Geiger

16-11

Geiger ✓

Smith

Roberts ✓

Roberts ✓

6-0

Atwell ✓

Forfeit - Separated shoulder
Alcorn

forfeit

Roberts ✓

Parker

Johnson

Durham

1989 STATE WRESTLING TOURNAMENT

Denver R. Andrews
General Manager



Andrews Travel Service Inc.
P.O. Box 2824 - 1634 Taylor Street
Columbia, S.C. 29202-2824
Telephone (803) 252-0992
Toll Free 1-800-662-4204

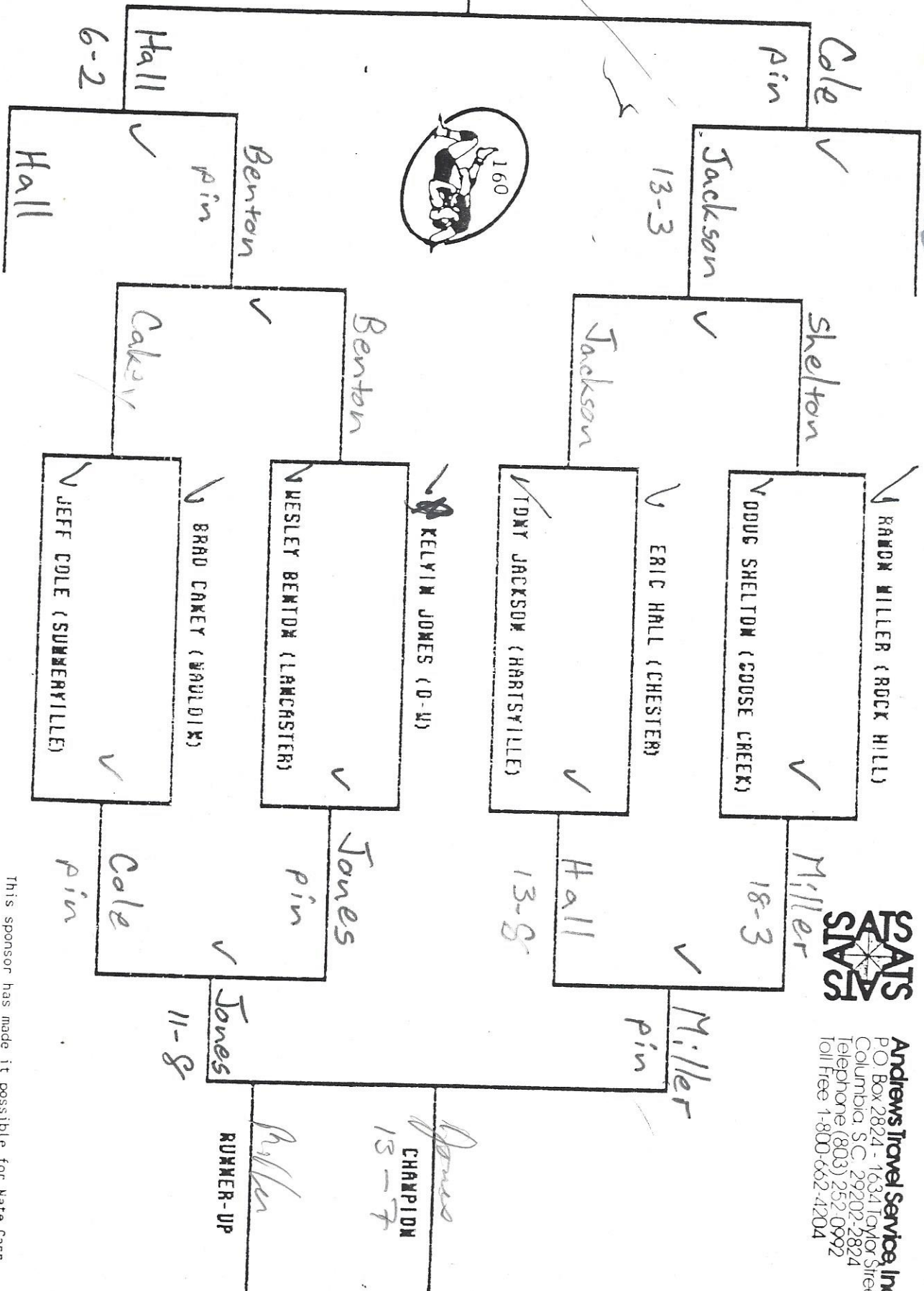

This sponsor has made it possible for Nate Carr to be at the SC Wrestling Tournament. Thanks!

SC Freestyle Association

This sponsor has made it possible for Nate Carr to be at the SC Wrestling Tournament. Thanks!

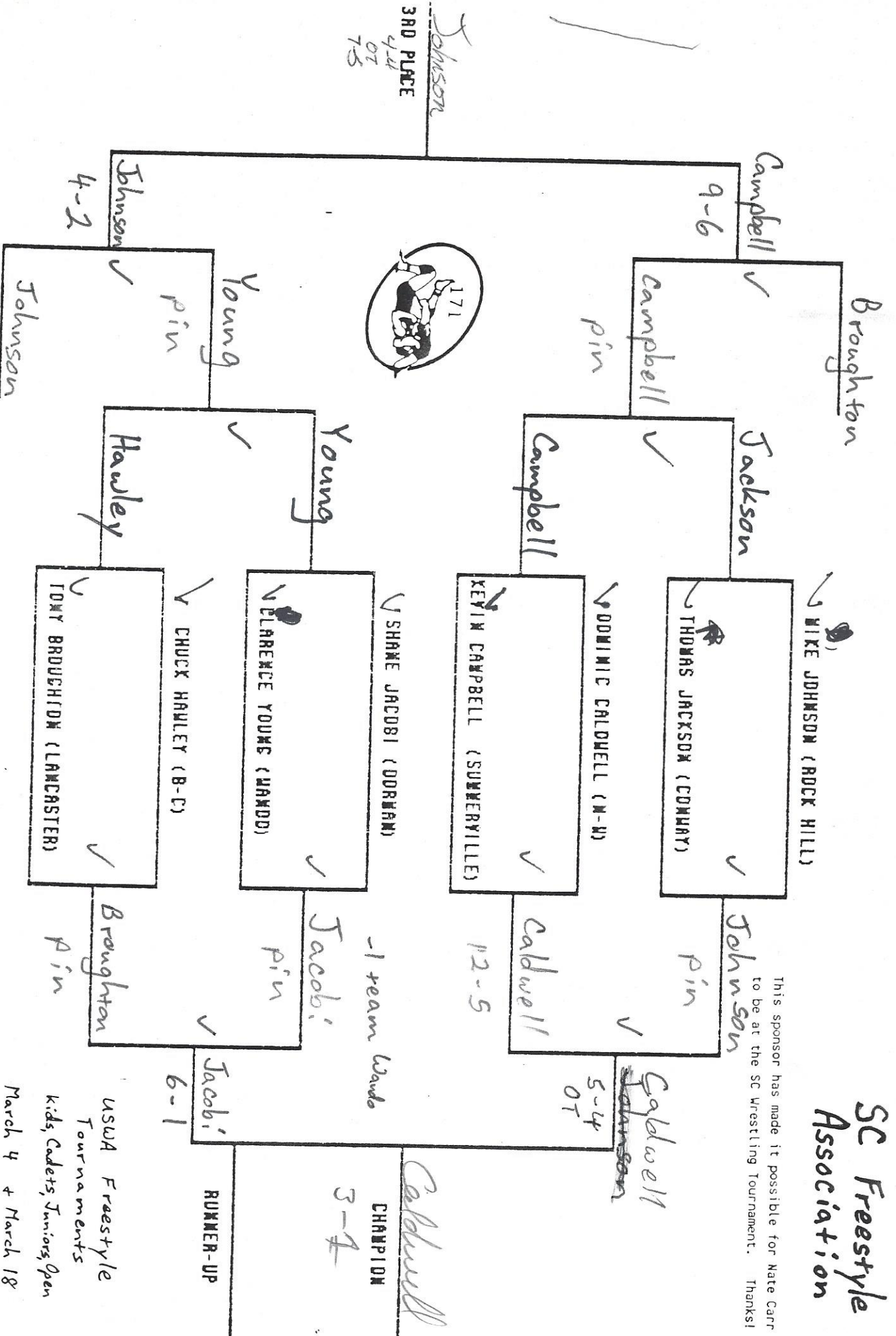

USWA Freestyle Tournaments
Kids, Cadets, Juniors, Open
March 4 + March 18
at Spring Valley
weigh in 8-9 am
clinic 9-10 "
wrestle 10 "
USWA Card #15 Entry \$5

1989 STATE WRESTLING TOURNAMENT

SCREEN EAST
 SUMMERVILLE
 S.C.

T SHIRTS UNLIMITED
 Columbia
 S.C.

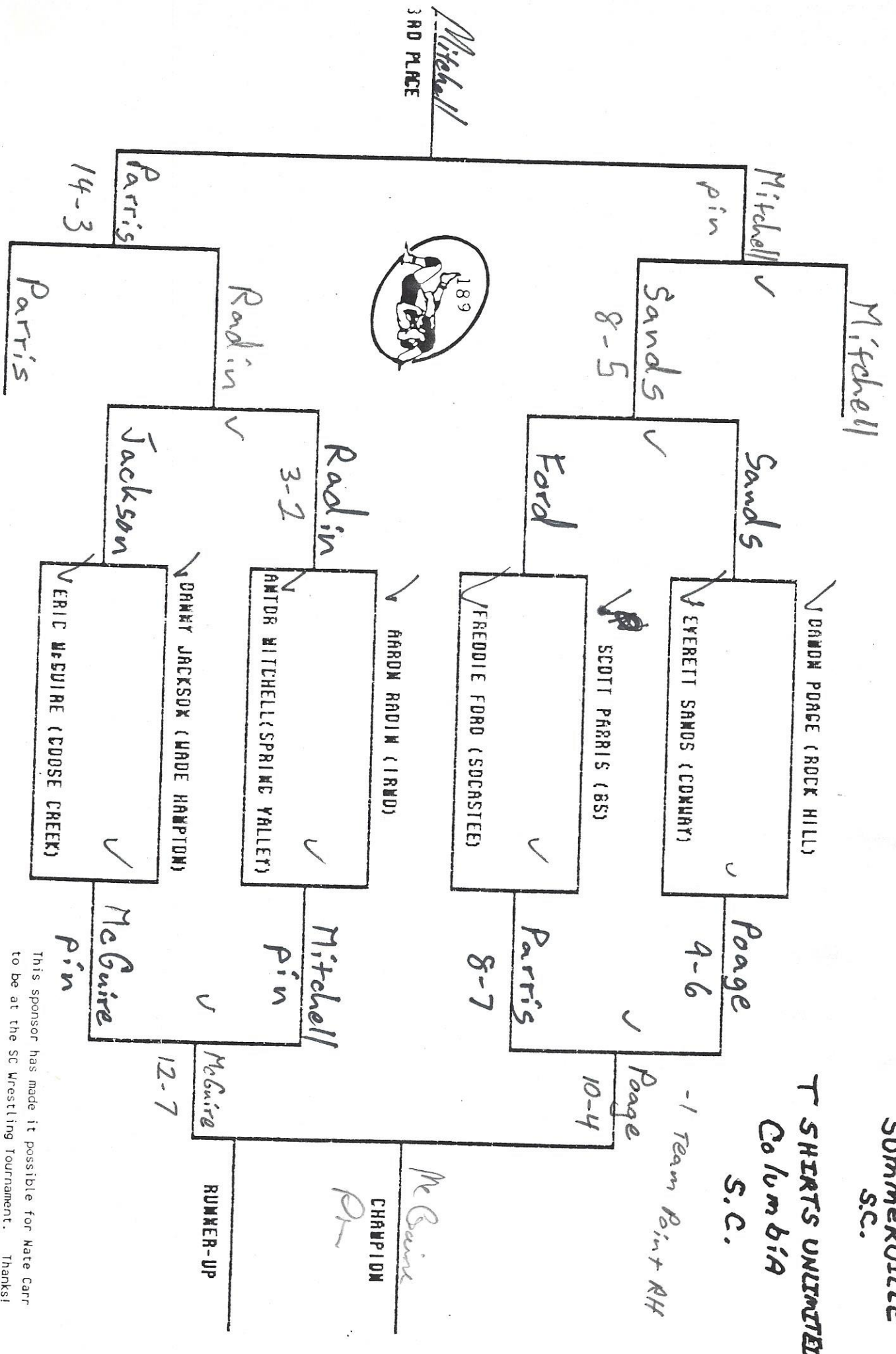

This sponsor has made it possible for Nate Carr
 to be at the SC Wrestling Tournament. Thanks!

1989 STATE WRESTLING TOURNAMENT

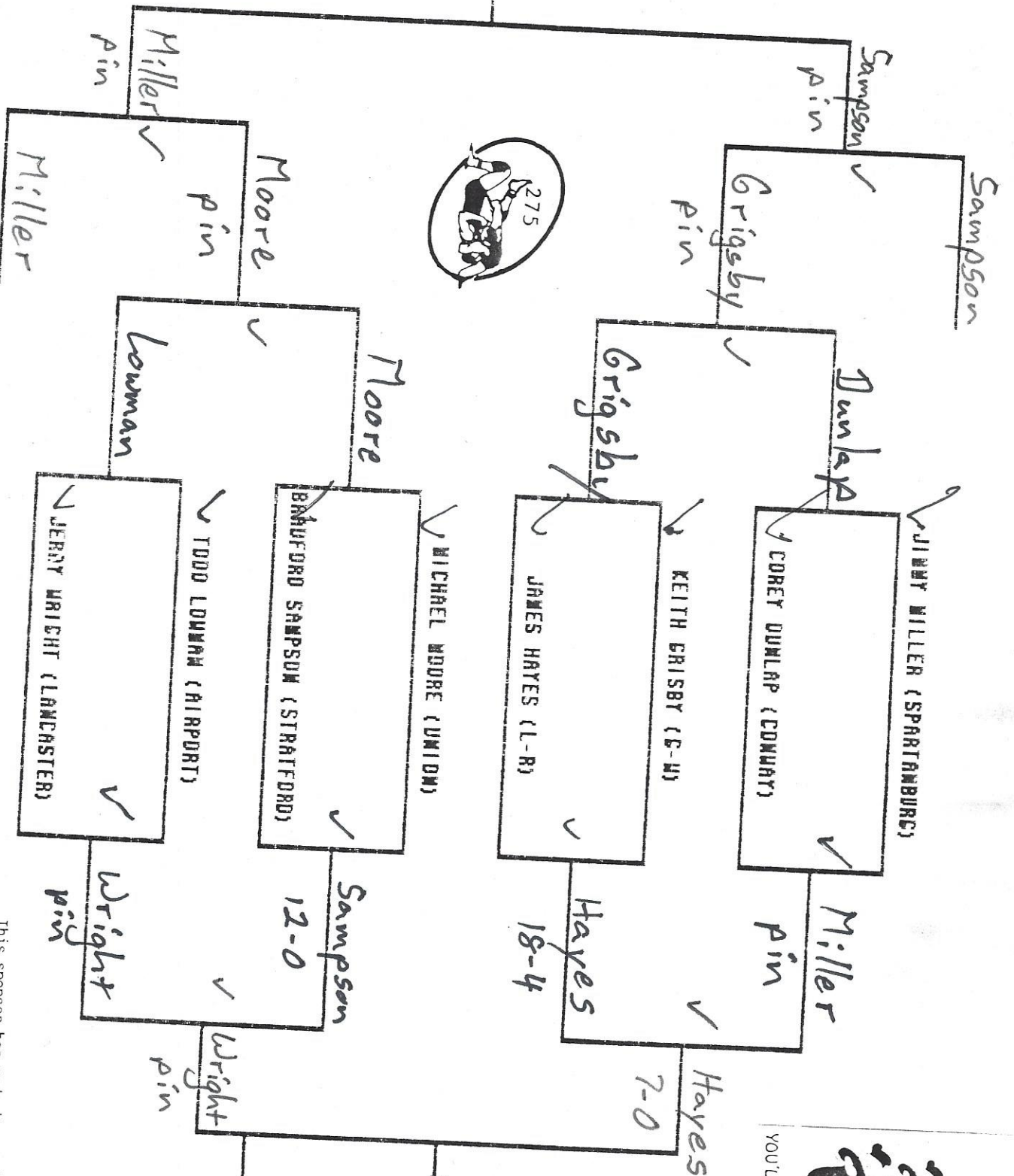

RUSH'S RUSH'S RUSH'S

YOU'LL RUSH... BACK FOR MORE!

FOR DELICIOUS FOOD... FIRST!

CHAMPION

8-1

RUNNER-UP

This sponsor has made it possible for Nate Carr to be at the SC Wrestling Tournament. Thanks!

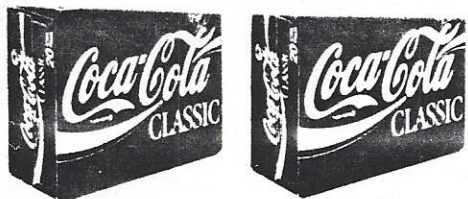

GILLIS COLEMAN, INC.

P.O. Box 13255 COLUMBIA, SC 29201

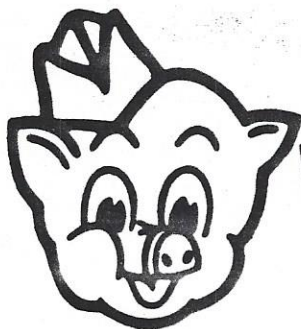

**piggly
wiggly**



**Kentucky
Fried Chicken**

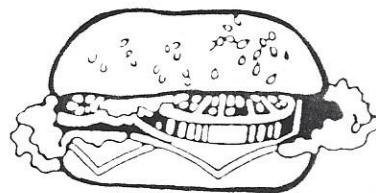

*These Companies
have provided
for all of
the needs in
the Hospitality Room.*

Thanks!

MATHIAS SANDWICH SHOP
7235 ST. ANDREWS ROAD
COLUMBIA, S.C. 29212
781-6144



Mister Donut
6801 St. Andrews Rd.
Columbia, SC 29210

William B. Pierce
Owner

*Complimentary
Donut and Coffee*

(803) 781-7287

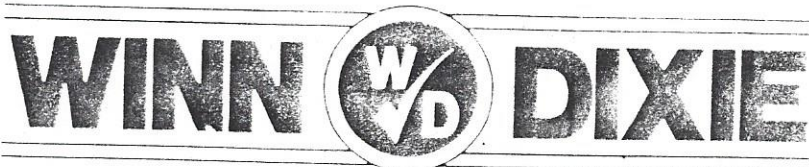
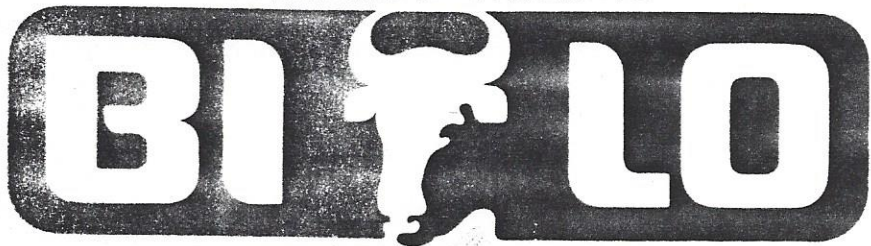

**Lizard's
Thicket**
REAL 'COUNTRY COOKING'

